

Force

- Peak: 344 - 860 N
- Continuous: 61 - 119N

Maximum Velocity

- Up to 5.6 m/s

Feedback

- Built-in position sensor
- 1V pk-pk sin/cos
- 12 micron repeatability

Range of motion

- 28~310 mm

Dimensions

- W x H: 100 x 86mm
- Rod diameter: 25mm

Applications

- Packaging
- Material Handling
- Automated Assembly
- Bio-medical

The OEM advantage

- Ready-to-use actuator requires no bearing support
- Flexible position control
- High speed and acceleration
- Clean, quiet operation
- No maintenance or adjustment



The ServoTube Actuator high rigidity actuator with integrated outrigger-bearings is an ideal solution for applications with high side-loading. A ball-bushing option with steel bearing rails provides maximum side-loading support. Polymer bushings use aluminium rails for reduced weight and are ideal for vertical loads.

Iron-sleeve design produces up to 20% more force than standard ServoTube actuator. Four models deliver a continuous force range of 61~119N (14~27lb) with peak forces up to 860N (193lb). Twelve stroke lengths are available from 28~310mm.

The patented magnetic design of ServoTube generates 12 micron (0.47 mil) repeatability and 350 micron (14 mil) accuracy from a non-contact, integral position sensor. No external encoder is required. Position output is industry standard 1V pk-pk sin/cos signals.

ServoTube is an ideal OEM solution for easy integration into pick-and-place gantries and general purpose material handling machines. The load is mounted directly to the industry standard mounting plate.

ServoTube has superior thermal efficiency, radiating heat uniformly. High duty cycles are possible without the need for forced-air or water cooling.

ELECTRICAL SPECIFICATIONS

FORCER TYPE	2504		2506		2508		2510		units
	S ⁽¹⁾	P ⁽¹⁾	S ⁽¹⁾	P ⁽¹⁾	S ⁽¹⁾	P ⁽¹⁾	S ⁽¹⁾	P ⁽¹⁾	
Peak force @ 25°C ambient for 1 sec	344	172	516	258	688	344	860	430	N
Peak current @ 25°C ambient for 1 sec	20		20		20		20		Apk
With 25 x 25 x2.5cm heatsink plate									
Continuous stall force @ 25°C ambient ⁽²⁾	60.7		81.8		101.2		119.4		N
Continuous stall current @ 25°C ambient	2.49	4.98	2.24	4.48	2.08	4.16	1.96	3.92	Arms
	3.53	7.06	3.17	6.34	2.94	5.88	2.78	5.56	Apk
Without heatsink plate									
Continuous stall force @ 25°C ambient ⁽²⁾	52.2		72.3		90.4		108.0		N
Continuous stall current @ 25°C ambient	2.15	4.30	1.98	3.96	1.86	3.72	1.78	3.56	Arms
	3.03	6.06	2.80	5.60	2.63	5.26	2.51	5.02	Apk
Force constant (sine commutation)	24.3	12.1	36.5	18.2	48.6	24.3	60.8	30.4	N/Arms
	17.2	8.6	25.8	12.9	34.4	17.2	43.0	21.5	N/Apk
Back EMF constant (phase to phase)	19.9	9.9	29.8	14.9	39.7	19.8	49.7	24.8	Vpk/m/s
Fundamental forcer constant	7.53		9.22		10.65		11.90		N/√W
Eddy current loss	2.35		2.35		2.35		2.35		N/m/s
Sleeve cogging force	2.2		3.2		3.3		3.0		+/-N
Resistance @ 25°C (phase to phase)	5.40	1.35	8.11	2.03	10.81	2.70	13.51	3.38	Ohm
Resistance @ 100°C (phase to phase)	6.96	1.74	10.45	2.61	13.93	3.48	17.41	4.35	Ohm
Inductance @ 1kHz (phase to phase)	4.32	1.08	6.48	1.62	8.64	2.16	10.80	2.70	mH
Electrical time constant	0.80		0.80		0.80		0.80		ms
Maximum working voltage	380		380		380		380		V d.c.
Pole pitch (one electrical cycle)	51.2		51.2		51.2		51.2		mm
Peak acceleration ^(3,5)	225	113	288	144	334	167	369	185	m/s ²
Maximum speed ^(4,5)	5.6	4.1	5.3	5.0	4.8	5.5	4.3	5.8	m/s
Peak acceleration ^(3,6)	276	138	354	177	413	206	458	229	m/s ²
Maximum speed ^(4,6)	6.1	4.6	5.7	5.5	5.1	6.2	4.5	6.3	m/s

Notes:

- ⁽¹⁾ S=series forcer phases, P=parallel forcer phases
- ⁽²⁾ Reduce continuous stall force to 89% at 40°C ambient
- ⁽³⁾ Based on a moving thrust rod with 28mm stroke and no payload
- ⁽⁴⁾ Based on a moving thrust rod with triangular move over maximum stroke and no payload
- ⁽⁵⁾ -B bush bearing option
- ⁽⁶⁾ -P polymer bearing option

THERMAL SPECIFICATIONS

FORCER TYPE	2504	2506	2508	2510	units
Maximum phase temperature	100	100	100	100	°C
Thermal resistance Rth _{phase-housing}	0.39	0.28	0.23	0.19	°C/Watt
With 25 x 25 x2.5cm heatsink plate					
Power dissipation @ 25°C ambient	65.0	78.8	90.4	100.6	Watt
Thermal resistance Rth _{housing-ambient}	0.76	0.67	0.60	0.56	°C/Watt
Without heatsink plate					
Power dissipation @ 25°C ambient	48.1	61.5	72.1	82.4	Watt
Thermal resistance Rth _{housing-ambient}	1.17	0.94	0.81	0.72	°C/Watt
Thermal time constant	1639	1773	1940	2080	s

MECHANICAL SPECIFICATIONS

FORCER TYPE	2504	2506	2508	2510	units
Maximum stroke	310	310	310	310	mm
Forcer mass	1.65	2.25	2.85	3.45	kg
Moving mass (-B bush bearing option)	0.25+(overall length (m) x 5.24)				kg
Moving mass (-P polymer bearing option)	0.25+(overall length (m) x 4.10)				kg

MECHANICAL RIGIDITY

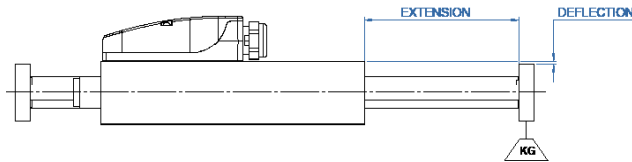

- 0kg
- 2kg
- 5kg
- 10kg

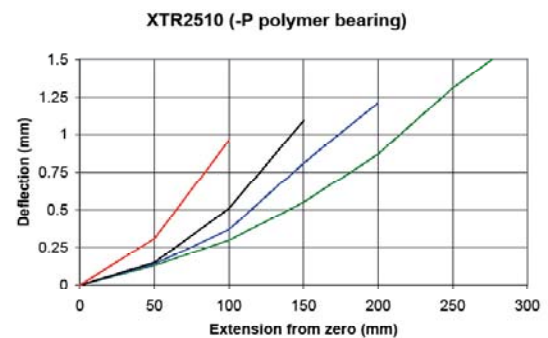
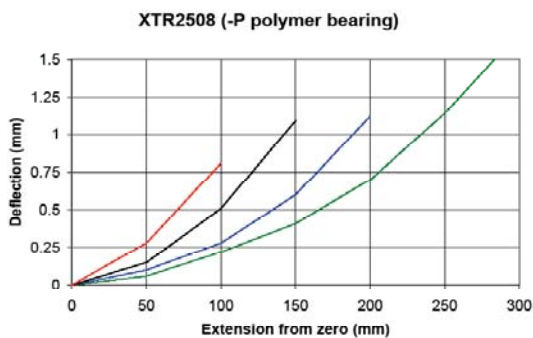
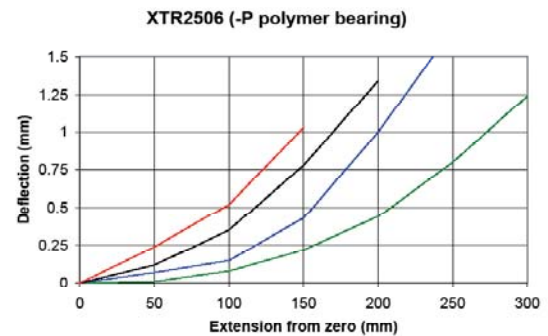
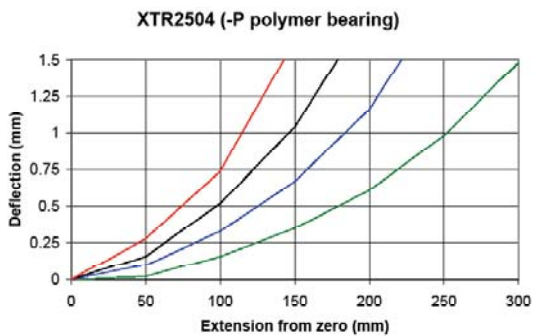
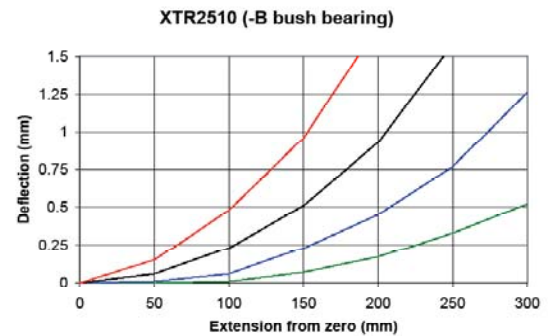
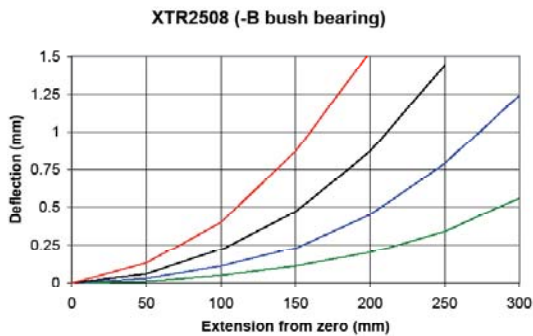
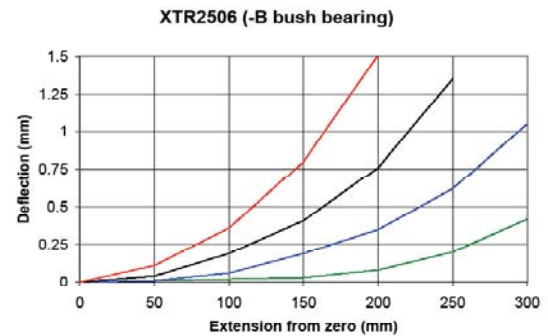
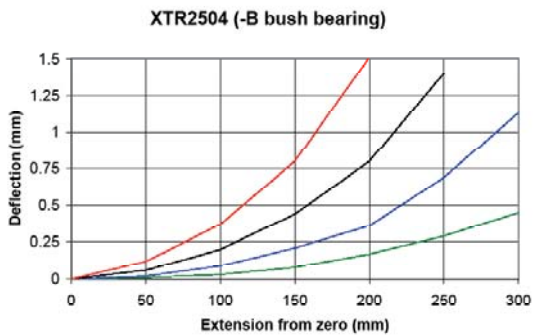

PAYLOAD VERSUS EXTENSION FOR 10.000KM LIFE

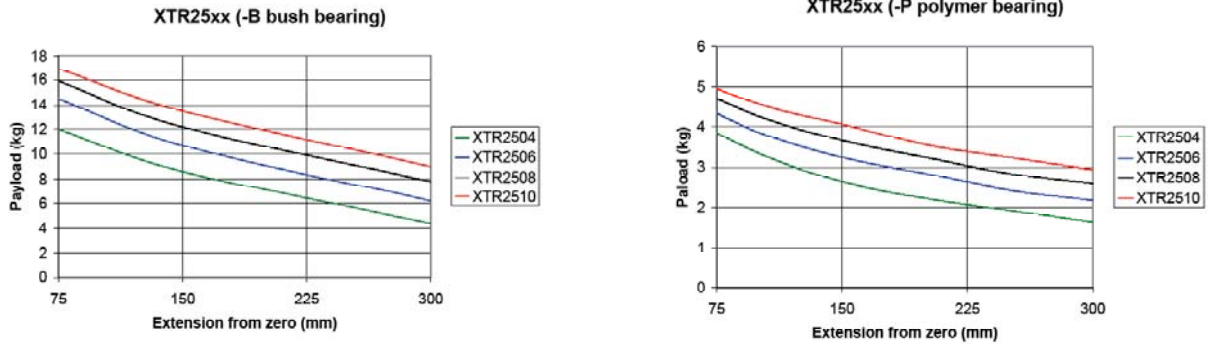

OUTLINE DRAWINGS

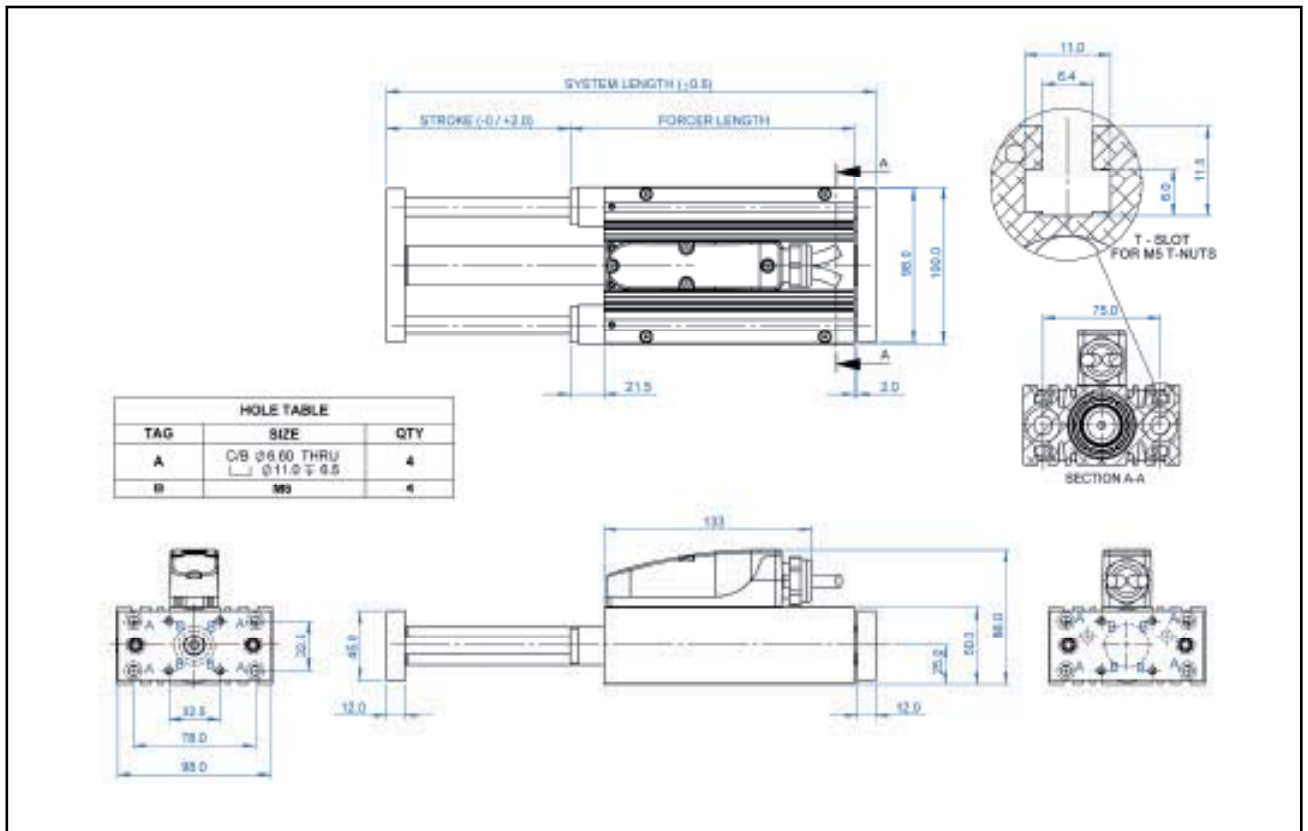

Minimum stroke (mm)	System length (mm)			
	XTR2504	XTR2506	XTR2508	XTR2510
28	236	287	339	390
54	262	313	364	415
79	287	339	390	441
105	313	364	415	467
131	339	390	441	492
156	364	415	467	518
182	390	441	492	544
207	415	467	518	569
233	441	492	544	595
259	467	518	569	621
284	492	544	595	646
310	518	568	621	672

Forcer	Forcer length (mm)
XTR2504	181.5
XTR2506	232.5
XTR2508	283.5
XTR2510	334.5

POSITION SENSOR

The position sensor outputs analogue, differential sine and cosine signals for providing position feedback. Shown below are the relationships between forcer phase back EMF and position sensor outputs for one direction of motion (as shown by arrows). It should be noted that +SIN or -SIN is always in phase with forcer phase U. For the motion shown, -SIN is in phase with forcer phase U. For motion in the opposing direction +SIN is in phase with forcer phase U.

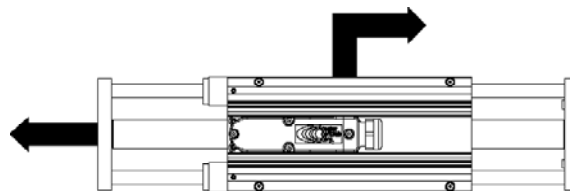
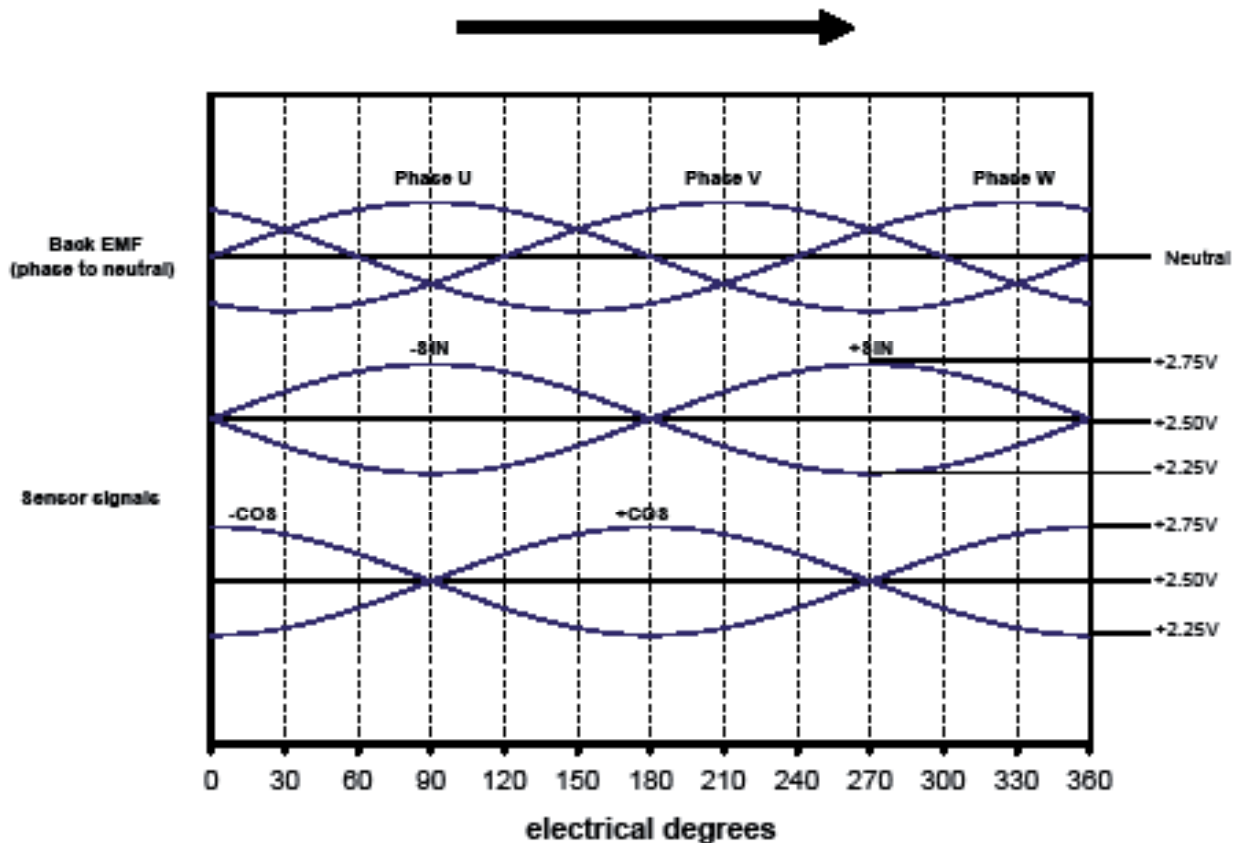

SPECIFICATION	VALUE	units
Output signal period	51.2	mm
Signal amplitude (between +/- signals)	1	Vpk-pk
Output current	± 10	mA
Supply voltage	5 ± 0.25	Vd.c.
Supply current (output current=0)	15 ± 5	mA
Resolution ⁽¹⁾	12	micron
Position repeatability ⁽²⁾	± 12	micron
Absolute accuracy ⁽³⁾	± 350	micron

Notes:

⁽¹⁾ Dependent on amplifier

⁽²⁾ Dependent on amplifier. Under constant operating conditions. Self-heating of the forcer will cause expansion in the thrust rod during the initial warm up period. In high duty applications (corresponding to an internal forcer temperature of 80°C) a 1 metre thrust rod will expand typically by 250 microns.

⁽³⁾ Maximum error over 1 metre under constant operating conditions.

FORCER OVER TEMPERATURE SENSOR



It is strongly recommended that the forcer over-temperature sensor is connected to the drive amplifier or servo controller **at all times** in order to reduce the risk of damage to the forcer due to excessive temperatures.

Protection is provided by three positive temperature coefficient (PTC) thermistors embedded in the forcer phases. As the forcer phase temperature approaches 100°C, the PTC thermistors exhibits a sharp increase in electrical resistance. This change in resistance can be detected by circuitry within the drive amplifier or servo controller and used to reduce or disable the output of the drive amplifier in order to protect the forcer.

SPECIFICATION	VALUE	units
Resistance in the temperature range -20°C to + 70°C	60 to 750	Ohms
Resistance at 85°C	≤1650	Ohms
Resistance at 95°C	≥3990	Ohms
Resistance at 105°C	≥12000	Ohms
Maximum continuous voltage	30	Vd.c.

FORCER ELECTRICAL CONNECTIONS

Connections are made within the termination box.

PIN NUMBER	FUNCTION
1	Phase U
2	Phase V
3	Phase W
Chassis	Earth/Screen

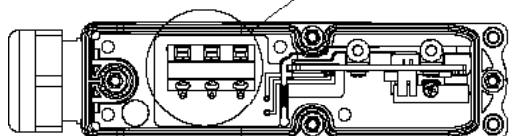
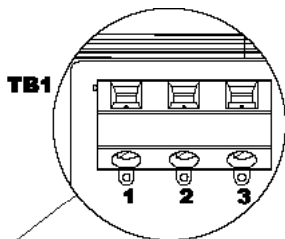

PIN NUMBER	FUNCTION
1	+SIN
2	-SIN
3	+COS
4	-COS
5	+5Vd.c.
6	0V
7	+TH (Thermistor)
8	-TH (Thermistor)

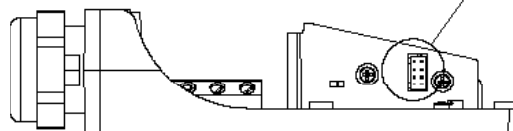
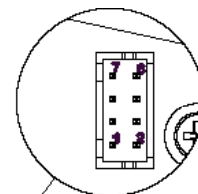

CABLE TYPE

The XTR has two separate cables providing connections for forcer power and position sensor. There are two cable types available with option S being supplied as standard. Both cable types are available in 3 metre or 5 metre lengths.

Option S cables are flexible but are not intended for continuous flex or drag chain applications.

OPTION S SPECIFICATION	POWER	SENSOR
Overall diameter (nominal)	8.2mm	6.5mm
Outer jacket material	PVC	PVC
Number of conductors	4	4 x twisted pair
Size of conductors	1.5mm ² (16 AWG)	0.14mm ² (26AWG)
Screened / Unscreened	Screened	Screened
Minimum bending radius - fixed routing	41mm	33mm
Operating temperature - fixed routing	-40°C to +90°C	-30°C to +70°C

Option R cables are suitable for continuous flex or drag chain applications.

OPTION R SPECIFICATION	POWER	SENSOR
Overall diameter (nominal)	7.6mm	5.8mm
Outer jacket material	PUR	PUR
Number of conductors	4	4 x twisted pair
Size of conductors	1.5mm ² (22 AWG)	0.14mm ² (26AWG)
Screened / Unscreened	Screened	Screened
Minimum bending radius - flexible routing	38mm	44mm
Operating temperature - flexible routing	-40°C to +80°C	-40°C to +90°C
Operating temperature - fixed routing	-40°C to +80°C	-40°C to +90°C

CABLE TERMINATION

The XTR cable is available with six termination options. **Option F** has the wire ends stripped and solder tinned ready for termination. All other options are terminated with connectors that plug directly into the desired amplifier. The connections for all options are shown below: -

SENSOR FUNCTION	D-(XTL-S)	F-Flying leads
+SIN	14	Blue
-SIN	13	Red
+COS	12	White
-COS	11	Brown
+5Vd.c.	4	Yellow
0V	5	Green
+TH (Thermistor)	10	Pink
-TH (Thermistor)	15	Grey
SCREEN	1+ shell	SCREEN
Connector type	15-way high density D	-
Amplifier connection	J8	-
POWER FUNCTION		
Forcer phase U	4	Black <u>1</u>
Forcer phase V	3	Black <u>2</u>
Forcer phase W	2	Black <u>3</u>
Earth (forcer body)	1	Green/Yellow
SCREEN	1	SCREEN
Connector type	4-way 5mm pluggable terminal	-
Amplifier connection	J2	-

ENVIRONMENT

The XTR is intended for use in an environment within the following conditions:

SPECIFICATION	VALUE
Operating temperature	0°C to +40°C
Storage temperature	-25°C to +70°C
Ingress protection	IP67
Altitude (above mean sea level)	1000m
Overvoltage category	II
Pollution degree	2
EMC	light industrial

In addition, the XTR is available with two environmental coating options. **Option S** has the forcer body coated with a 25 micron layer of black anodise that is suitable for general use. **Option H** has the forcer body coated with a 90 micron layer of hard natural anodise that is suitable for harsher environments. This option is available at a minimum quantity of 25 pieces per year.

ORDER CODES

Actuator

XTR25 □ □ □ - □ □ □ □ - □ - □ □ □ □ - □ □

Forcer
04, 06, 08, 10

Winding
S - Series
P - Parallel

Stroke
028, 054, 079, 105, 131, 156
182, 207, 233, 259, 284, 310
Stroke in mm

Bearing
B - Bush
P - Polymer

Environment
S - Standard
H - Harsh (on request)

Brake
blank - no brake
BR - Brake

Cable Termination
D - Xenus (XTL-S)
F - Flying leads

Cable Length
03 - 3 m
05 - 5 m
10 - 10 m

Cable Type
S - Non-Robotic
R - Robotic