

#### Force

- Peak: 312 - 780 N
- Continuous: 51 - 102N

#### Maximum Velocity

- Up to 5.9 m/s

#### Feedback

- Built-in position sensor
- 1V pk-pk sin/cos
- 12 micron repeatability

#### Range of motion

- 27~309 mm

#### Dimensions

- W x H: 54 x 95mm
- Rod diameter: 25mm

#### Applications

- Packaging
- Material Handling
- Automated Assembly
- Bio-medical

#### The OEM advantage

- Reliable and cost-effective
- Flexible position control
- High speed and acceleration
- Clean, quiet operation
- No maintenance or adjustment



The ServoTube Actuator is an optimal solution for industrial position control. Faster than a ballscrew with the clean reliability of a linear forcer. ServoTube is a cost-effective alternative to air cylinders in applications requiring greater flexibility and control.

The ServoTube Actuator incorporates an IP67 rated forcer and a sealed stainless steel thrust rod enclosing rare-earth magnets. Four models deliver a continuous force range of 51~102 N (11~23 lb) with peak forces up to 780 N (175 lb). Twelve stroke lengths are available from 27~309 mm.

The patented magnetic design of ServoTube generates 12 micron (0.47 mil) repeatability and 350 micron (14 mil) accuracy from a non-contact, integral position sensor. No external encoder is required. Position output is industry standard 1V pk-pk sin/cos signals.

An internal dry bearing provides clean, quiet, maintenance-free performance. Life expectancy far exceeds typical ballscrew solutions.

The ServoTube Actuator is ideal for push/pull/lift material handling, packaging and automated assembly applications. ServoTube accepts a range of industry standard accessories for simple mechanical integration.

## ELECTRICAL SPECIFICATIONS

FORCER TYPE	2504		2506		2508		2510		units
	S <sup>(1)</sup>	P <sup>(1)</sup>	S <sup>(1)</sup>	P <sup>(1)</sup>	S <sup>(1)</sup>	P <sup>(1)</sup>	S <sup>(1)</sup>	P <sup>(1)</sup>	
Peak force @ 25°C ambient for 1 sec	312	156	468	234	624	312	780	390	N
Peak current @ 25°C ambient for 1 sec	20		20		20		20		Apk
<b>With 25 x 25 x2.5cm heatsink plate</b>									
Continuous stall force @ 25°C ambient <sup>(2)</sup>	51.2		69.5		86.4		102.4		N
Continuous stall current @ 25°C ambient	2.31	4.62	2.10	4.20	1.96	3.92	1.86	3.72	Arms
	3.27	6.54	2.97	5.94	2.77	5.54	2.62	5.24	Apk
<b>Without heatsink plate</b>									
Continuous stall force @ 25°C ambient <sup>(2)</sup>	42.5		59.5		75.1		90.0		N
Continuous stall current @ 25°C ambient	1.92	3.84	1.80	3.60	1.70	3.40	1.63	3.26	Arms
	2.72	5.44	2.54	5.08	2.41	4.82	2.31	4.62	Apk
Force constant (sine commutation)	22.1	11.0	33.1	16.5	44.1	22.0	55.2	27.6	N/Arms
	15.6	7.8	23.4	11.7	31.2	15.6	39.0	19.5	N/Apk
Back EMF constant (phase to phase)	18.0	9.0	27.0	13.5	36.0	18.0	45.0	22.5	Vpk/m/s
Fundamental forcer constant	6.47		7.92		9.13		10.24		N/√W
Eddy current loss	9.51		12.55		15.58		18.61		N/m/s
Resistance @ 25°C (phase to phase)	6.02	1.50	9.02	2.25	12.03	3.01	15.04	3.76	Ohm
Resistance @ 100°C (phase to phase)	7.75	1.94	11.63	2.91	15.51	3.88	19.39	4.85	Ohm
Inductance @ 1kHz (phase to phase)	3.90	0.97	5.85	1.46	7.80	1.95	9.75	2.44	mH
Electrical time constant	0.65		0.65		0.65		0.65		ms
Maximum working voltage	380		380		380		380		V d.c.
Pole pitch (one electrical cycle)	51.2		51.2		51.2		51.2		mm
Peak acceleration <sup>(3)</sup>	394	197	483	241	542	271	586	293	m/s <sup>2</sup>
Maximum speed <sup>(4)</sup>	5.9	4.4	5.3	5.1	4.7	5.6	4.2	5.8	m/s

### Notes:

<sup>(1)</sup> S=series forcer phases, P=parallel forcer phases

<sup>(2)</sup> Reduce continuous stall force to 89% at 40°C ambient

<sup>(3)</sup> Based on a moving thrust rod with 27mm stroke and no payload

<sup>(4)</sup> Based on a moving thrust rod with triangular move over maximum stroke and no payload

## THERMAL SPECIFICATIONS

FORCER TYPE	2504	2506	2508	2510	units
Maximum phase temperature	100	100	100	100	°C
Thermal resistance Rth <sub>phase-housing</sub>	0.41	0.27	0.20	0.16	°C/Watt
<b>With 25 x 25 x2.5cm heatsink plate</b>					
Power dissipation @ 25°C ambient	62.3	77.0	89.2	100.2	Watt
Thermal resistance Rth <sub>housing-ambient</sub>	0.79	0.69	0.64	0.59	°C/Watt
<b>Without heatsink plate</b>					
Power dissipation @ 25°C ambient	43.1	56.4	67.6	77.3	Watt
Thermal resistance Rth <sub>housing-ambient</sub>	1.33	1.06	0.91	0.81	°C/Watt
Thermal time constant	1188	1276	1377	1486	s

## MECHANICAL SPECIFICATIONS

FORCER TYPE	2504	2506	2508	2510	units
Maximum stroke	309	309	309	309	mm
Forcer mass (excluding thrust rod and cable)	1.25	1.70	2.25	2.65	kg
Thrust rod mass/metre	3.5	3.5	3.5	3.5	kg/m

OUTLINE DRAWINGS

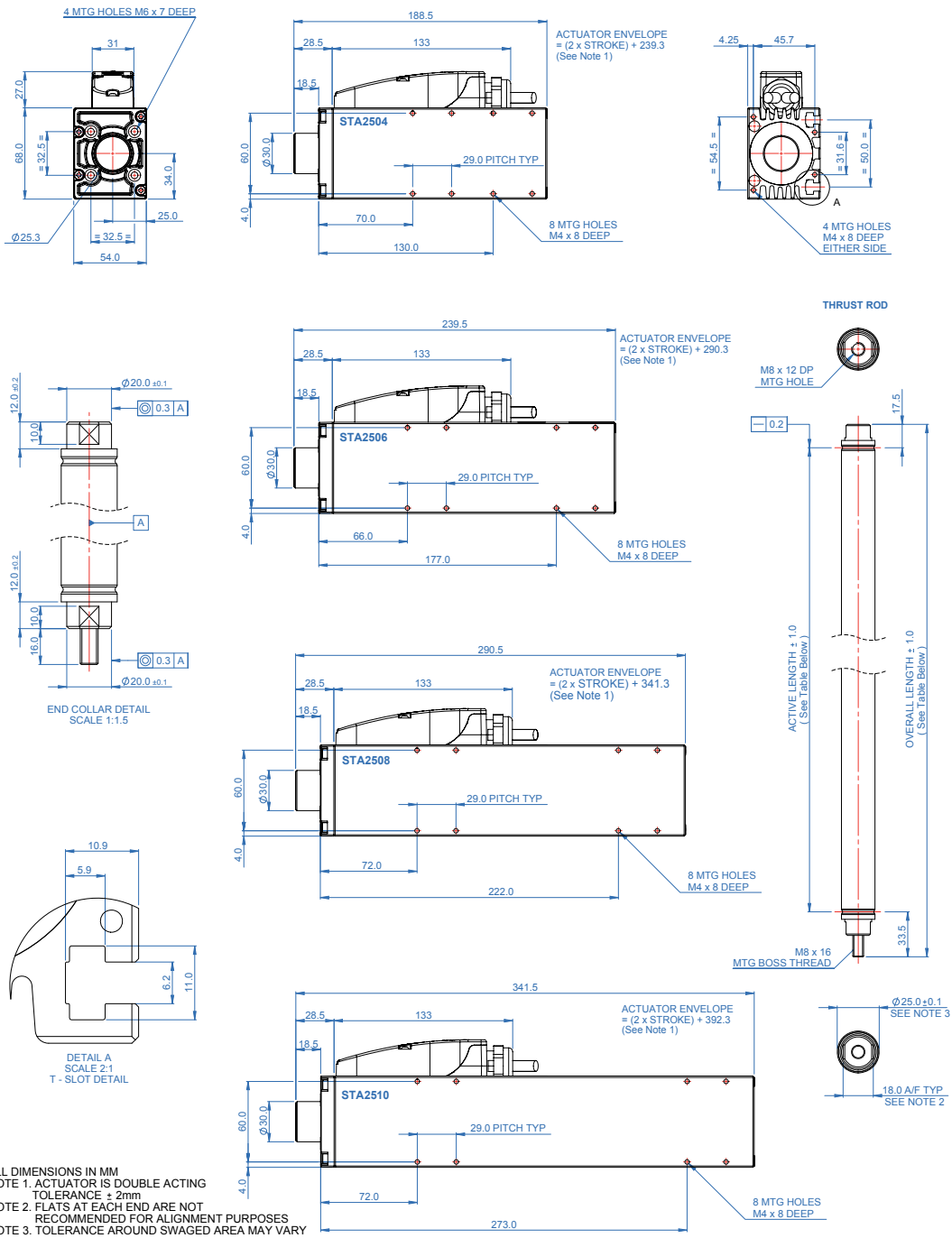

Stroke (mm)	2504	2506	2508	2510
27	266	317	368	419
53	292	343	394	445
78	317	368	419	470
104	343	394	445	496
130	369	420	471	522
155	394	445	496	547
181	420	471	522	573
206	445	496	547	598
232	471	522	573	624
258	497	548	599	650
283	522	573	624	676
309	548	599	650	701

Longer strokes are possible depending on the application

**POSITION SENSOR**

The position sensor outputs analogue, differential sine and cosine signals for providing position feedback. Shown below are the relationships between forcer phase back EMF and position sensor outputs for one direction of motion (as shown by arrows). It should be noted that +SIN or -SIN is always in phase with forcer phase U. For the motion shown, -SIN is in phase with forcer phase U. For motion in the opposing direction +SIN is in phase with forcer phase U.

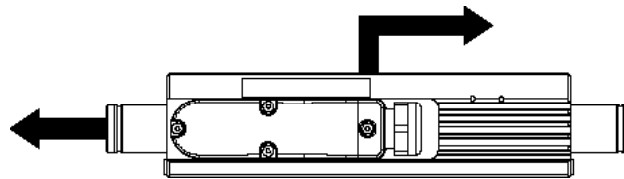
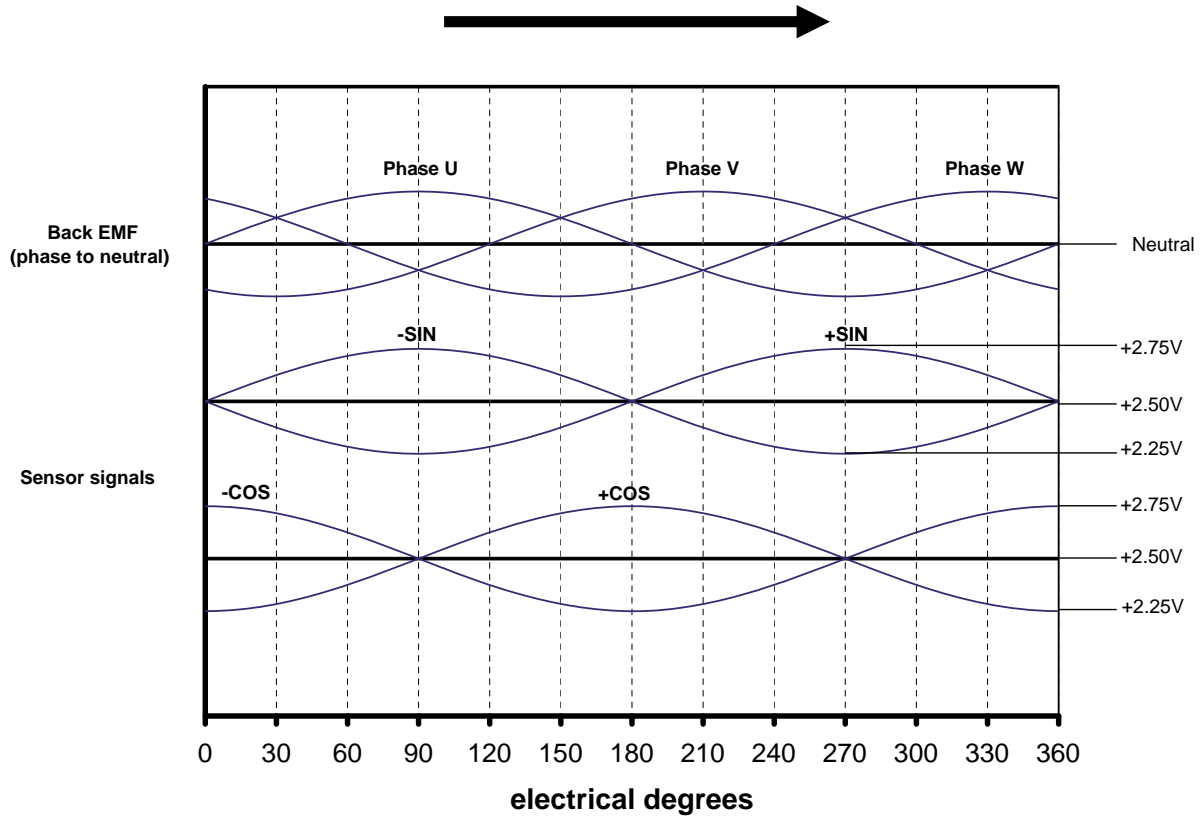

SPECIFICATION	VALUE	units
Output signal period	51.2	mm
Signal amplitude (between +/- signals)	1	Vpk-pk
Output current	$\pm 10$	mA
Supply voltage	$5 \pm 0.25$	Vd.c.
Supply current (output current=0)	$15 \pm 5$	mA
Resolution <sup>(1)</sup>	12	micron
Position repeatability <sup>(2)</sup>	$\pm 12$	micron
Absolute accuracy <sup>(3)</sup>	$\pm 350$	micron

**Notes:**

<sup>(1)</sup> Dependent on amplifier

<sup>(2)</sup> Dependent on amplifier. Under constant operating conditions. Self-heating of the forcer will cause expansion in the thrust rod during the initial warm up period. In high duty applications (corresponding to an internal forcer temperature of 80°C) a 1 metre thrust rod will expand typically by 250 microns.

<sup>(3)</sup> Maximum error over 1 metre under constant operating conditions.

## FORCER OVER TEMPERATURE SENSOR



It is strongly recommended that the forcer over-temperature sensor is connected to the drive amplifier or servo controller **at all times** in order to reduce the risk of damage to the forcer due to excessive temperatures.

Protection is provided by three positive temperature coefficient (PTC) thermistors embedded in the forcer phases. As the forcer phase temperature approaches 100°C, the PTC thermistors exhibits a sharp increase in electrical resistance. This change in resistance can be detected by circuitry within the drive amplifier or servo controller and used to reduce or disable the output of the drive amplifier in order to protect the forcer.

SPECIFICATION	VALUE	units
Resistance in the temperature range -20°C to + 70°C	60 to 750	Ohms
Resistance at 85°C	≤1650	Ohms
Resistance at 95°C	≥3990	Ohms
Resistance at 105°C	≥12000	Ohms
Maximum continuous voltage	30	Vd.c.

## FORCER ELECTRICAL CONNECTIONS

Connections are made within the termination box.

PIN NUMBER	FUNCTION
1	Phase U
2	Phase V
3	Phase W
Chassis	Earth/Screen

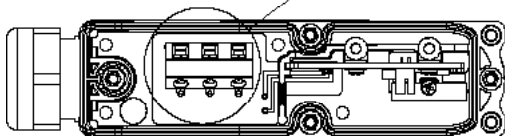
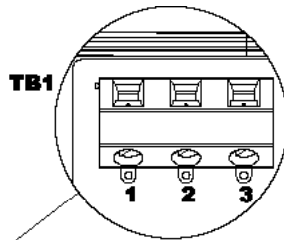

PIN NUMBER	FUNCTION
1	+SIN
2	-SIN
3	+COS
4	-COS
5	+5Vd.c.
6	0V
7	+TH (Thermistor)
8	-TH (Thermistor)

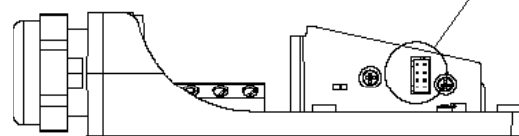
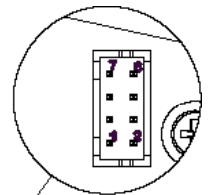

## CABLE TYPE

The STA has two separate cables providing connections for forcer power and position sensor. There are two cable types available with option S being supplied as standard. Both cable types are available in 3 metre or 5 metre lengths.

**Option S** cables are flexible but are not intended for continuous flex or drag chain applications.

OPTION S SPECIFICATION	POWER	SENSOR
Overall diameter (nominal)	8.2mm	6.5mm
Outer jacket material	PVC	PVC
Number of conductors	4	4 x twisted pair
Size of conductors	1.5mm <sup>2</sup> (16 AWG)	0.14mm <sup>2</sup> (26AWG)
Screened / Unscreened	Screened	Screened
Minimum bending radius - fixed routing	41mm	33mm
Operating temperature - fixed routing	-40°C to +90°C	-30°C to +70°C

**Option R** cables are suitable for continuous flex or drag chain applications.

OPTION R SPECIFICATION	POWER	SENSOR
Overall diameter (nominal)	7.6mm	5.8mm
Outer jacket material	PUR	PUR
Number of conductors	4	4 x twisted pair
Size of conductors	1.5mm <sup>2</sup> (16 AWG)	0.14mm <sup>2</sup> (26AWG)
Screened / Unscreened	Screened	Screened
Minimum bending radius - flexible routing	38mm	44mm
Operating temperature - flexible routing	-40°C to +80°C	-40°C to +90°C
Operating temperature - fixed routing	-40°C to +80°C	-40°C to +90°C

## CABLE TERMINATION

The STA cable is available with six termination options. **Option F** has the wire ends stripped and solder tinned ready for termination. All other options are terminated with connectors that plug directly into the desired amplifier. The connections for all options are shown below: -

SENSOR FUNCTION	D-(XTL-S)	F-Flying leads
+SIN	14	Blue
-SIN	13	Red
+COS	12	White
-COS	11	Brown
+5Vd.c.	4	Yellow
0V	5	Green
+TH (Thermistor)	10	Pink
-TH (Thermistor)	15	Grey
SCREEN	1+ shell	SCREEN
Connector type	15-way high density D	-
Amplifier connection	J8	-
POWER FUNCTION		
Forcer phase U	4	Black <u>1</u>
Forcer phase V	3	Black <u>2</u>
Forcer phase W	2	Black <u>3</u>
Earth (forcer body)	1	Green/Yellow
SCREEN	1	SCREEN
Connector type	4-way 5mm pluggable terminal	-
Amplifier connection	J2	-

## ENVIRONMENT

The STA is intended for use in an environment within the following conditions:

SPECIFICATION	VALUE
Operating temperature	0°C to +40°C
Storage temperature	-25°C to +70°C
Ingress protection	IP67
Altitude (above mean sea level)	1000m
Overvoltage category	II
Pollution degree	2
EMC	light industrial

In addition, the STA is available with two environmental coating options. **Option S** has the forcer body coated with a 25 micron layer of black anodise that is suitable for general use. **Option H** has the forcer body coated with a 90 micron layer of hard natural anodise that is suitable for harsher environments. This option is available at a minimum quantity of 25 pieces per year.

## ORDER CODE

### Actuator

**STA25** □ □ □ - □ □ □ - □ - □ □ □ □ - □ □

#### Forcer

04, 06, 08, 10

#### Winding

S - Series  
P - Parallel

#### Stroke

027, 053, 078, 104, 130, 155  
181, 206, 232, 258, 283, 309  
Stroke in mm

#### Environment

S - Standard  
H - Harsh (on request)

#### Brake

blank - no brake  
BR - Brake

#### Cable Termination

D - Xenus (XTL-S)  
F - Flying leads

#### Cable Length

03 - 3 m  
05 - 5 m  
10 - 10 m

#### Cable Type

S - Non-Robotic  
R - Robotic